

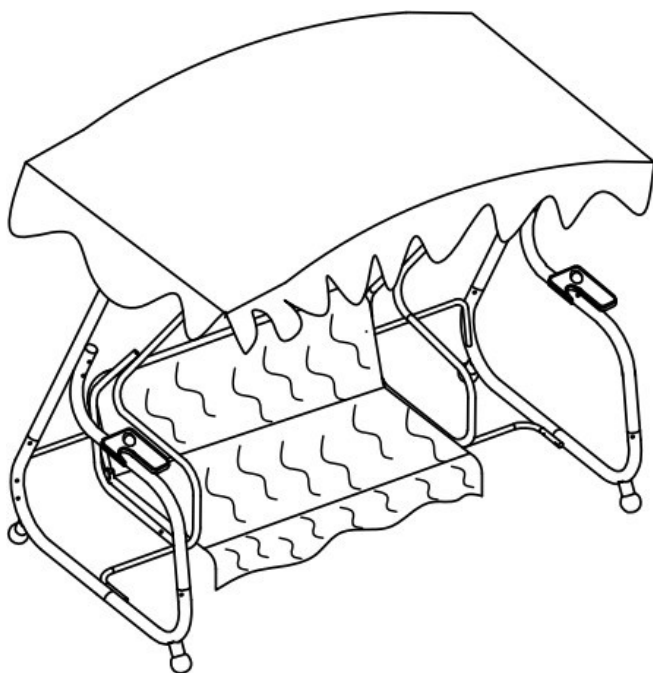

# blumfeldt

Hollywoodska vrtna njihaljka



10030568 10030611

**Poštovani,**

Zahvaljujemo vam na kupnji ovog proizvoda. Molimo pročitajte ovaj priručnik i slijedite ove upute za montažu, kako biste izbjegli oštećenja na uređaju. Za štete uzrokovane nepridržavanjem instrukcija i uputa, ne snosimo odgovornost.

## Model

**Broj predmeta**

**10030568 10030611**

Hollywood swing

## Használati és biztonsági tudnivalók













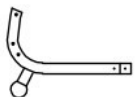













### **Sigurnosne upute**

- Prilikom rasklapanja njihaljke ne držite ruke na pokretnim dijelovima.
- Provjerite je li njihaljka čvrsto montirana i stabilna.

### **Čišćenje i održavanje**

- Obrišite njihaljku vlažnom krpom.
- Ne koristite abrazivna sredstva za čišćenje niti jake deterdžente

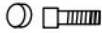
## Popis sastavnih dijelova

<p>A</p>  <p>1PC</p>	<p>B</p>  <p>2PCS</p>	<p>C</p>  <p>2PCS</p>	<p>D</p>  <p>2PCS</p>	
<p>E</p>  <p>1PC</p>	<p>F</p>  <p>2PCS</p>	<p>G</p>  <p>1PC</p>	<p>H</p>  <p>2PCS</p>	<p>I</p>  <p>2PCS</p>
<p>J</p>  <p>2PCS</p>	<p>K</p>  <p>1PC</p>	<p>M</p>  <p>2PCS</p>	<p>N</p>  <p>2PCS</p>	<p>O</p>  <p>1PC</p>
<p>P</p>  <p>1PC</p>	<p>Q</p>  <p>1PC</p>	<p>R</p>  <p>2PCS</p>	<p>S</p>  <p>M6*80 4PCS</p>	<p>T</p>  <p>M6*85 4PCS</p>
<p>U</p>  <p>M6*65 2PCS</p>	<p>V</p>  <p>M6*25 2PCS</p>	<p>W</p>  <p>M8*58 6PCS</p>	<p>X</p>  <p>M8*110 4PCS</p>	
<p>Y</p>  <p>M8*70 2PCS</p>	<p>Z</p>  <p>M6*38 2PCS</p>	<p>Z</p>  <p>1PC</p>	<p>Z1</p>  <p>1PC</p>	

# Montaža

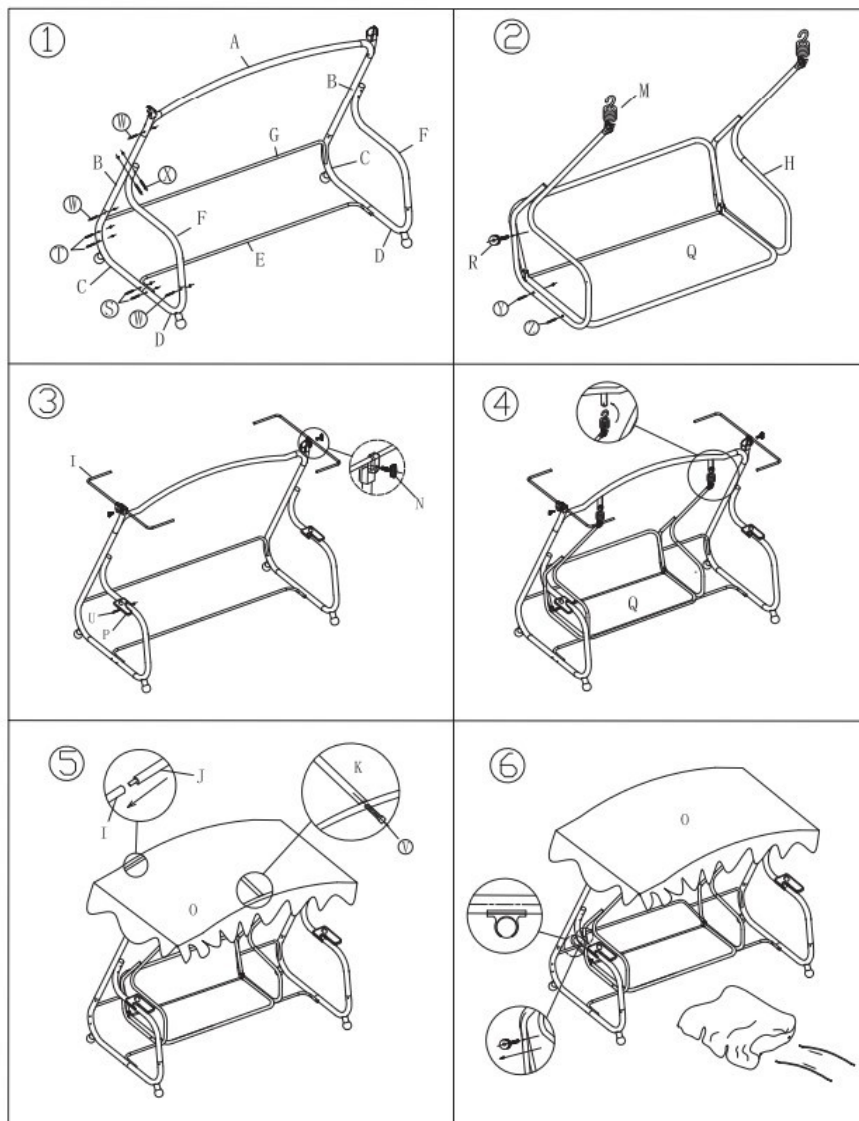

Proizvođač: Chal-Tec GmbH, Wallstraße 16, 10179 Berlin, Njemačka